

Pneumatic Retractable Fittings

Pharm

Food



SensoGate® WA 130 H

Pneumatic sensor lock-gate for demanding fully automated process applications in hygienic areas

Easy installation and clear hose connections

SensoGate® WA 130 H offers genuine Plug & Play: The central multiplug is simultaneously linked via a single connection to all rinsing, cleaning, and calibration media as well as the control air and limit-position mechanisms. With the complete interior media routing and the multiplug, the connection is just as safe as it is convenient. Media entrainment is minimized and the limit-position mechanism is reliably protected.



SensoGate® with central multiplug

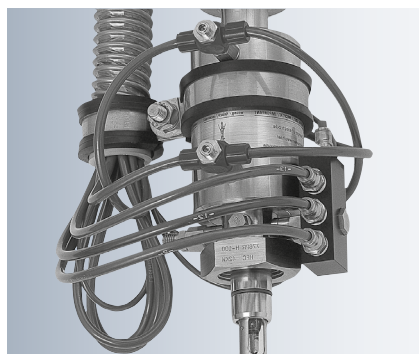

Conventional retractable fittings: Tangled hoses (left) and deposits on unprotected limit-position mechanism (right)

Systematic, Fully Automatic Liquid Analysis

The combination of the SensoGate® WA 130 H retractable fitting with the Uniclean® 900 (cleaning) or Uniclean® 9000 (cleaning and calibration) control units and the Protos® 3400 measuring system enables fully automated measuring stations with an outstandingly high level of precision and reliability. The system offers the highest levels of safety with monitoring of the compressed air and water supply, the probe position, and the buffer and cleaning solution levels.

Maximum stability and precision due to patented metering-pump technology with separate routing of the media. Short-time measurements and regular cleaning enable longer sensor life. The production process is neither interrupted by automatic cleaning nor by calibrations.



Additional Media Connection for Superheated Steam or Chemical Applications

- additional media connection decoupled by integrated check valve
- easy access
- no dead spots
- valve with high flow rate

Uncompromising Hygienic Design of the Calibration Chamber

The process-wetted parts as well as the calibration chamber of the SensoGate® WA 130H Sensor Lock-Gate have validated sterilization capability. This means that it is suitable for unrestricted use in pharmaceutical and food applications and also allows validation in FDA-regulated production processes. A special design enables the directed flow to the process seal.

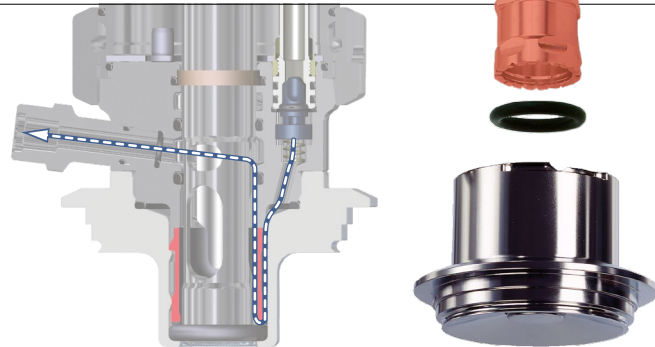

Sterilizable and cleanable calibration chamber with special flow body

Facts

- steam-sterilizability validated for all process-wetted parts incl. rinsing/calibration chamber
- compact, smooth, and dirt-resistant design with interior media routing and integrated limit-position mechanism
- directed flow rinses the process seal from the process side as well as from the inside of the fitting
- perfect sensor cleaning effect by cyclone rinsing
- safe separation to the process during probe movement and prevention of re-contamination
- double gaskets with leakage bores prevent microbial contamination of the drive
- broad applications in hygienic conditions
- cost reduction by simple installation, operation, and maintenance
- very high availability
- protective rinsing of the seals for a long service life
- SensoLock for high safety of operation
- integrated check valves and limit switches
- fast and uncomplicated replacement of calibration chamber and immersion tube
- all maintenance can be performed on site
- superior sensor immersion depth
- standard sensor length (225 mm) even for large immersion depths
- multiple process connections available
- process-wetted parts: stainless steel 1.4404, electropolished
- modular design
- special version for sensors with pressurizable liquid electrolyte
- SIP and CIP capable in the process
- SIP and CIP of calibration chamber and media routing

FDA

Pneumatic Retractable Fittings

Pharm

Food

SensoGate® WA 130 H for hygienic applications

The Versions Available

- material: 1.4404, electropolished
- variants: short and "long" immersion depths; liquid- or gel-filled sensors; adapter for free hose connection
- ball bearings for easy detachability
- process adaptations:
 - dairy pipe DN 50 ... 100
 - Ingold socket 25 mm
 - clamp 1.5" ... 3.5"
 - Varivent DN 50 ... 80
 - BioControl DN 50, DN 65

*SensoGate® WA 130 H,
mounted in a
Varivent housing*



WA 130 H
Dairy pipe



WA 130 H
Ingold socket
1.4404

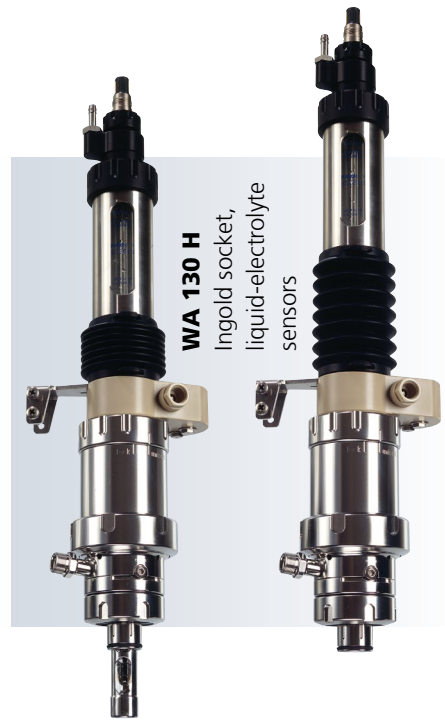

WA 130 H
Ingold socket,
liquid-electrolyte
sensors



WA 130 H
Clamp, short



WA 130 H
Clamp, long



WA 130 H
Varivent

Specifications

Ambient temperature	5 ... 70 °C
Permissible process temp	5 ... 140 °C
Permitted process pressure during movement	6 bars gauge pressure at 140 °C
Permissible static pressure	16 bars (40 °C) in service position
Air supply	4 ... 7 bars, filtered 10 ... 25 µm, oil- and condensate-free
Effective immersion depth	33 mm, measured from lower edge of flange to sensor tip (Varivent version)
Total immersion depth incl. immersion tube	46 mm
Process adaptations*)	dairy-pipe screw joint, DN 50/DN 65/DN 80 Ingold socket, 1.4404, 25 mm (G 1 1/4") Clamp 2", 1.4404 Varivent, DN 50 – 125, 1.4404
Sensors	225 mm, Pg-13.5 coupling, 250 mm for pressurized liquid-electrolyte sensors
Rinse-medium inlet	1) for Unical® 9000/Uniclean® 900: Connection with hose grommet and coupling 2) for manual control: ZU 0631/ZU 0646
Rinse-medium outlet	connection: hose grommet with coupling
Rinse function	seal rinsing during stroke movement
Process-wetted materials	stainless steel, 1.4404
Enclosure	stainless steel, 1.4571
Ingress protection	IP 66
Connection to Uniclean® 900/Unical® 9000	compact multiplug connection
Sensor protection in the process	integrated in immersion tube
Limit switches	noncontacting electrical limit-position control in conjunction with Uniclean® 900/Unical® 9000/ZU 0631
Certificates	3.1 Material Certificate (optional) ATEX II 1 GD c II

*) Special connections on request

Pneumatic Retractable Fittings

Pharm

Food

SensoGate® WA 130 H for hygienic applications

Product Line

Order No.

Hygienic sensor lock-gate, pneumatic		WA 130H /	<input type="checkbox"/>	<input type="checkbox"/>	<input type="checkbox"/>	<input type="checkbox"/>	<input type="checkbox"/>	<input type="checkbox"/>	<input type="checkbox"/>	<input type="checkbox"/>	-	<input type="checkbox"/>	<input type="checkbox"/>	<input type="checkbox"/>
Explosion protection	for hazardous area Zone 1 without	X N												
Sensor	solid electrolyte liquid electrolyte (pressurization possible)	0 1								A				
Gasket material	elastomeric ring set F, FKM elastomeric ring set E, EPDM FDA elastomeric ring set G, FFKM process-wetted elastomeric ring set H, FFKM complete	F E G H												
Process-wetted materials*)	1.4404/1.4404/1.4404 (electropolished)	G												
Process adaptation	dairy pipe, DN 50 dairy pipe, DN 65 dairy pipe, DN 80 Ingold socket, 1.4404, 25 mm (G 1 1/4") Ingold socket, hygienic, 1.4404, 25 mm (G 1 1/4") Clamp 1.5", 1.4404 Clamp 2", 1.4404 Clamp 2.5", 1.4404 Clamp 3", 1.4404 Clamp 3.5", 1.4404 Varivent, 1.4404, for pipe from DN 50 Varivent, 1.4404, for pipe from DN 50 short, from DN 80 long BioControl DN 50 BioControl DN 65	C 1 C 2 C 3 H 0 A H 1 A J 1 A J 2 J 3 J 4 J 5 V 1 A V 2 L 1 A L 2 A												
Immersion depth	short long	A B												
Connection	media connection, PEEK media connection, PEEK, integr. connection of add. medium	B C												
Special variant	without equipped with special grease (provided by customer) with scraper ring, reinforced version, PTFE/PEEK (ZU 0760)											0 0 0 0 0 1 0 0 3		

*) Material combinations: Process-wetted part of calibration chamber/rinse-wetted part of calibration chamber/immersion tube

Accessories (Details from page 270)

Order No.

Service set	basic equipment	ZU 0680
	maintenance, repair, retrofit	ZU 0740
	calibration chamber	ZU 0754
Mounting aid	for 20 x 2.5 O-rings	ZU 0747
	for scraper ring	ZU 0746
Bellows	version for liquid-electrolyte sensors	ZU 0739
Adapter for free hose connection	PP/EPDM (incl. electric feedback)	ZU 0733
	PP/EPDM (without electric feedback)	ZU 0734
	PEEK/EPDM (incl. electric feedback)	ZU 0742
Material Certificate 3.1		ZU 0708
Air supply	for pressurized sensors, 0.5 ... 4 bars	ZU 0670/1
	for pressurized sensors, 1 ... 7 bars	ZU 0670/2
Hose	20 m (extension for ZU 0670)	ZU 0713
Flange protectors	PEEK/FFKM DN 80	ZU 0755
	PEEK/FFKM DN 100	ZU 0756
	PVDF/FFKM DN 80	ZU 0757
	PVDF/FFKM DN 100	ZU 0758
Safety weld-in socket, straight, 40 mm	for tank wall	ZU 0717
	for pipe, DN 50	ZU 0717/DN50
	for pipe, DN 65	ZU 0717/DN65
	for pipe, DN 80	ZU 0717/DN80
	for pipe, DN 100	ZU 0717/DN100
Safety weld-in socket, beveled 15°, 40 mm	for tank wall	ZU 0718
	for pipe, DN 50	ZU 0718/DN50
	for pipe, DN 65	ZU 0718/DN65
	for pipe, DN 80	ZU 0718/DN80
	for pipe, DN 100	ZU 0718/DN100

Pneumatic Retractable Fittings

Pharm

Food

SensoGate® WA 130 H for hygienic applications

Gaskets		Set	Contact (process/rinse medium)	Order No.
Dairy pipe, Varivent, clamp	E/1	EPDM FDA	ZU 0700/1	
	E/2	EPDM FDA/EPDM FDA	ZU 0700/2	
	F/1	FKM FDA	ZU 0697/1	
	F/2	FKM FDA/FKM FDA	ZU 0697/2	
	G/1	FFKM FDA	ZU 0766/1	
	G/2	FFKM FDA/EPDM FDA	ZU 0766/2	
	H	FFKM FDA/FFKM FDA	ZU 0767	
	Ingold socket	E/1	EPDM FDA	ZU 0704/1
E/2		EPDM FDA/EPDM FDA	ZU 0704/2	
F/1		FKM FDA	ZU 0703/1	
F/2		FKM FDA/FKM FDA	ZU 0703/2	
G/1		FFKM FDA	ZU 0768/1	
G/2		FFKM FDA/EPDM FDA	ZU 0768/2	
H		FFKM/FFKM	ZU 0769	
Spare Parts				Order No.
Immersion tube, short	1.4404		ZU 0764	

Dimension Drawings

Installation dimensions for
SensoGate® WA 130 H
for sensors with liquid electrolyte

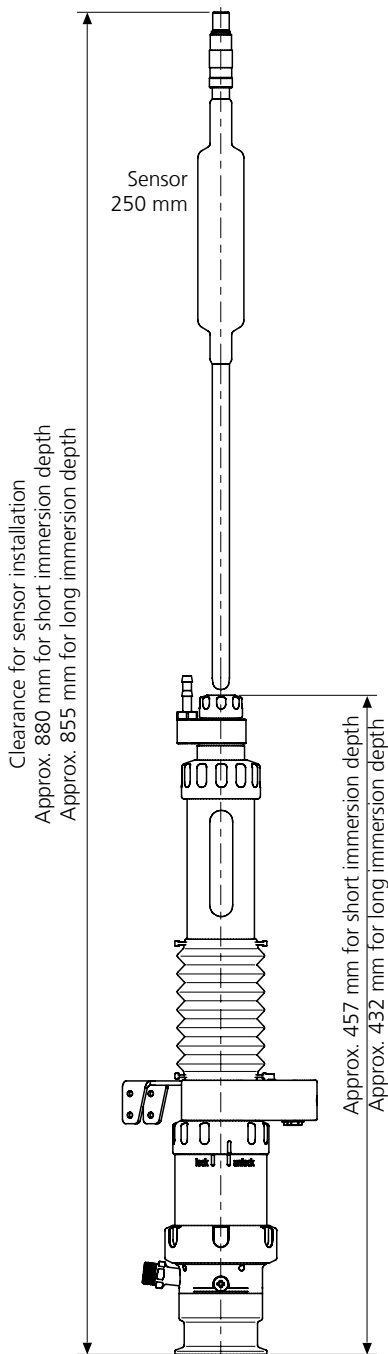

Installation dimensions for
SensoGate® WA 130 H
for sensors with gel electrolyte

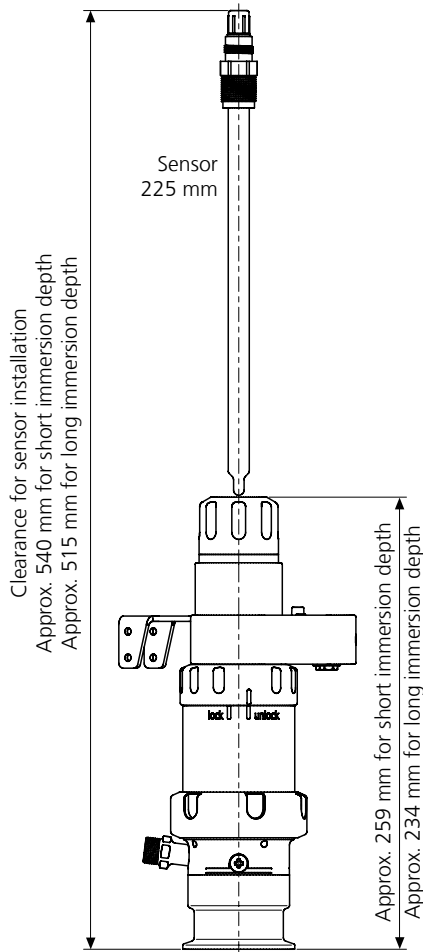

SensoGate® WA 130 H
Process adaptation for Varivent
DN 50, short immersion depth

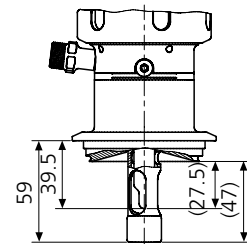

SensoGate® WA 130 H
Process adaptation for Varivent from
DN 80, long immersion depth

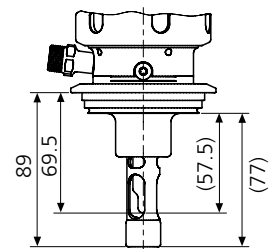

SensoGate® WA 130 H
Process adaptation for Varivent from
DN 65, short immersion depth

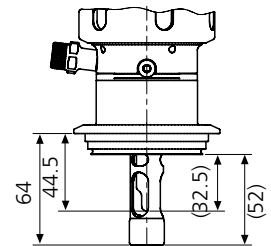

Pneumatic Retractable Fittings

Pharm

Food

SensoGate® WA 130 H for hygienic applications

Dimension Drawings – continued

SensoGate® WA 130 H
Process adaptation for
TriClamp 2" ... 3.5",
long immersion depth

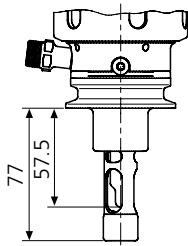

SensoGate® WA 130 H
Process adaptation for dairy pipe
DN 11851 DN 50 ... 100,
long immersion depth

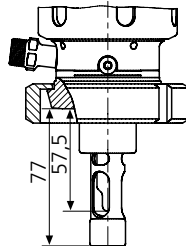

SensoGate® WA 130 H
Process adaptation for
Ingold socket, 25 mm
long immersion depth

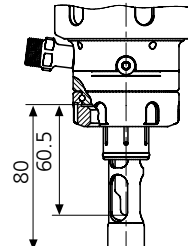

SensoGate® WA 130 H
Process adaptation for
TriClamp 1" ... 3.5",
short immersion depth

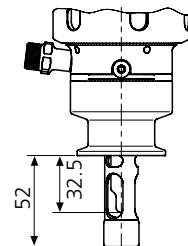

SensoGate® WA 130 H
Process adaptation for dairy pipe
DN 11851 DN 50 ... 100,
short immersion depth

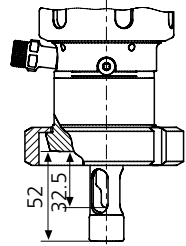

SensoGate® WA 130 H
Process adaptation for
BioControl DN 50/DN 65

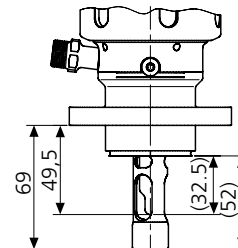

Knick >

DP-FLOW

www: www.dp-flow.co.uk email: sales@dp-flow.co.uk